

İNOVA

STEEL DIŐ TİCARET LTD. ŐTİ.

KATALOG

Türkiye'nin
Global Demir ve Çelik Tedarikçisi

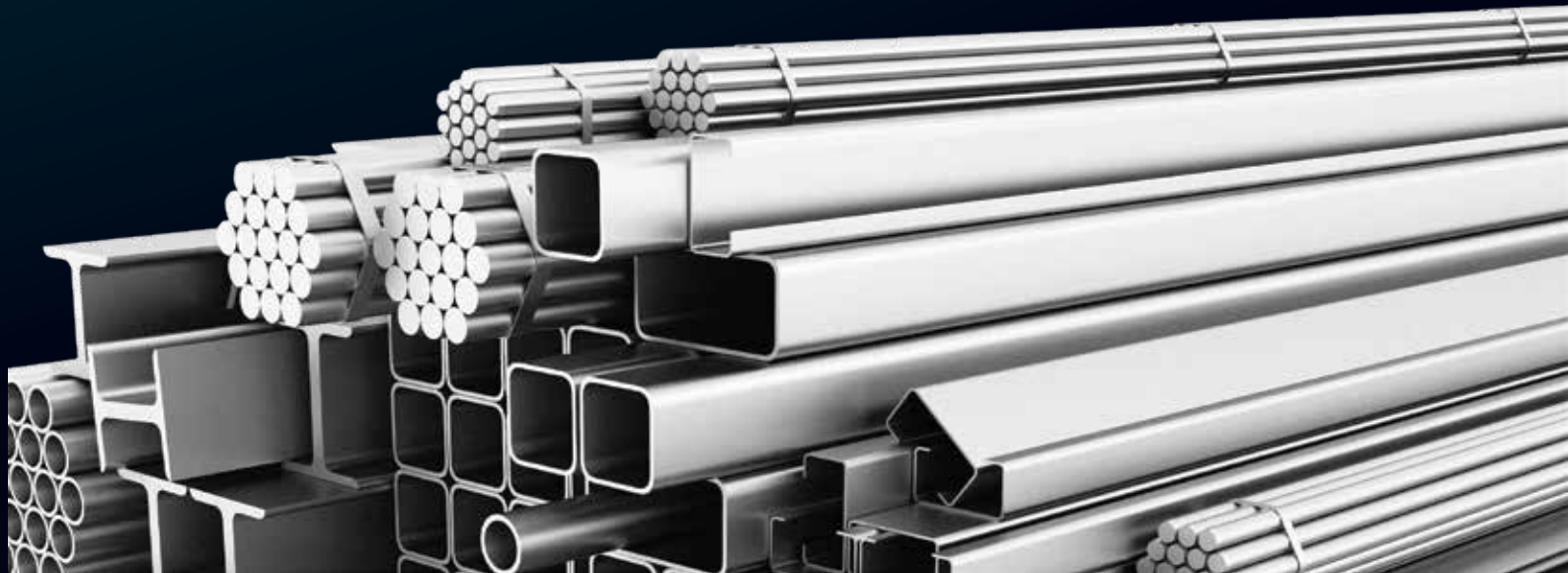



DEMİR VE
ÇELİKTE
YÜKSEK
KALİTE
ÜRÜNLER

Hakkımızda

INOVA STEEL

INOVA STEEL Dış Ticaret Limited Şirketi, İSO-9001, İSO-14001- İSO-45001- İSO-10002 akreditasyonlarına sahip Türkiye'nin Global Demir ve Çelik Tedarikçi şirkettir.

Ürünlerimiz

Hadde profil ürünleri,
Siyah sac,
Levha saçlar
DKP saçlar, galvanizli saçlar,
Corten,
Esnemeye mukavemetli saçlar MC kalite
Aşınmaya mukavemetli saçlar HB kalite
Kazan saçları P265GH P355GH kalite,
Filmaşın SEA1006 SEA1008 kalite.

www.inovasteel.com.tr

Uzun Hadde Mamüleri

Ürünlerimizi S235J0 - S235JR - S235J2 (ST37), S275J0 - S275JR - S275J2 (ST44), S355J0 - S355JR-S355J2 (ST52) kalitelerde ve Uluslararası kaliteler olan Avrupa EN 10025, Almanya DIN 17100, İngiltere BS 4360, Amerikan ASTM, Rusya GOST 380-94 kalite standartlarında üretebilmekteyiz.



Uzun Hadde Mamüleri

HEA PROFİL

Ebat: 100-1000 mm

Boy: 6-15 m

Boyutlar: EN 10365

Toleranslar EN 10034

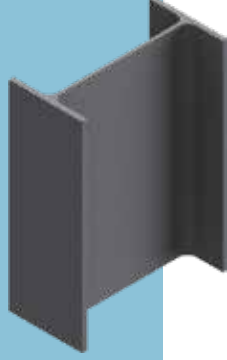

HEB PROFİL

Ebat: 100-1000 mm

Boy: 6-15 m

Boyutlar: EN 10365

Toleranslar EN 10034



IPN PROFİL

Ebat: 80-400 mm

Boy: 6-15 m

Boyutlar: EN 10365

Toleranslar EN 10024



IPE PROFİL

Ebat: 100-600 mm

Boy: 6-15 m

Boyutlar: EN 10365

Toleranslar EN 10034



UPN PROFİL

Ebat: 65 - 400 mm

Boy: 6-15 m

Boyutlar: EN 10365

Toleranslar: EN 10279



KÖŞEBENT DEMİR

Ebat: 20 - 250 mm

Boy: 6-15 m

Boyutlar: EN 10056-1

Toleranslar: EN 10056-2



HEM PROFİL

Ebat: 100-1000 mm

Boy: 6-15 m

Boyutlar: EN 10365

Toleranslar EN 10034



UB PROFİL

Ebat: 100-300 mm

Boy: 6-15 m

Boyutlar: BS 4-1

Toleranslar: EN 10034



UC PROFİL

Ebat: 100-200 mm

Boy: 6-15 m

Boyutlar: BS 4-1

Toleranslar: EN 10034

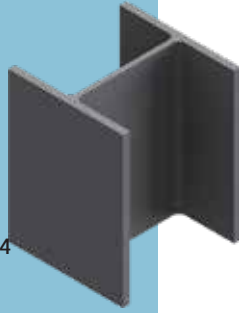

T PROFİL

Ebat: 20-140 mm

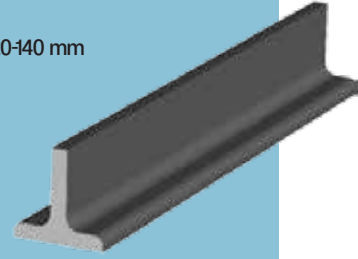

LAMA DEMİR

Genişlik: 10.00 mm - 250.00 mm

Kalınlık: 3.00 mm - 50.00 mm.

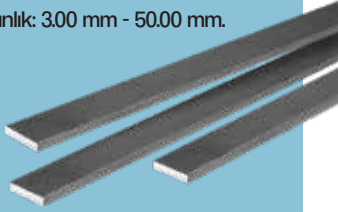

KARE DEMİR

Kalınlık: 8mm - 250 mm

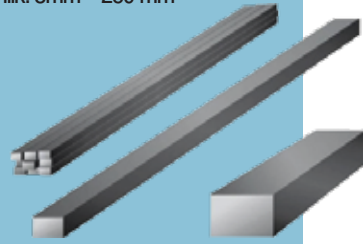

W PROFİL

Ebat: 100-300 mm

Boy: 6-15 m

Boyutlar: ASTM A6

Toleranslar: ASTM A6



PFC PROFİL

Ebat: 80 - 300 mm

Boy: 6-15 m

Boyutlar: BS 4-1

Toleranslar: EN 10279



FİLMAŞİN

Üretim Aralığı: 5,5 mm-25 mm

Ağırlık: 2050kg - 2400 kg

Dış çapı: 1250 mm

İç çapı: 850 mm

Boy: 1700-2200 mm



Avrupa Standartlarına Göre Alaşımsız Yapısal Çelik Kaliteleri

Uzun Yapısal Çelik Ürünlerinin Mekanik Özellikleri

Norm	Kalite	Minimum Akma Dayanımı R _{eH} N/mm ²						Çekme Mukavemeti R _m N/mm ²				Minimum Uzama L ₀ =5.65√S ₀ %					Çentik Darbe Testi		
		Nominal kalınlık (mm)						Nominal kalınlık (mm)				Nominal kalınlık (mm)					Sıcaklık	Min. Soğurulan Enerji	
		≤16	>16 ≤40	>40 ≤63	>63 ≤80	>80 ≤100	>100 ≤150	>150 ≤200	<3	≥3 ≤100	>100 ≤150	>150 ≤200	>3 ≤40	>40 ≤63	>63 ≤100	>100 ≤150	>150 ≤200	°C	J
EN 10025-2: 2004	S 235 JR	235	225		215		195	185	360-510	360-510	350-500	340-490	26	25	24	22	21	+20	27
	S 235 JO																0	27	
	S 235 J2 *																-20	27	
	S 275 JR	275	265	255	245	235	225	215	430-580	410-560	400-540	380-540	23	22	21	19	18	+20	27
	S 275 JO																0	27	
	S 275 J2 *																-20	27	
	S 355 JR	355	345	335	325	315	295	285	510-680	470-630	450-600	450-600	22	21	20	18	17	+20	27
	S 355 JO																	0	27
	S 355 J2																	-20	27
	S 355 K2																	-20	40
S 450 JO	450	430	410	390	380	380	-	-	550-720	530-700	-		17			-	0	27	

Çelik Kaliteleri Karşılaştırma Tablosu

Yapısal Çelikler

Materyal#	AVRUPA		ALMANYA	FRANSA	İTALYA	İNGİLTERE	ABD	JAPONYA		RUSYA
	EN 10025	EN 10025(90)	DIN 17100	NFA 35-501	UNI 7070	BS 4360	ASTM	JIS G3101	JIS 3106	GOST 380-94
1.0035	S 185	Fe 310-0	St 33	A 33	Fe 320		A 283 A / A 569 C / A 366 C	SS 330		
1.0037	S 235 JR	Fe 360 B	St 37-2	E 24-2	Fe 360 B	40 A	A 283 C / A 570 Gr 33, 36	SS 330		St2sp; ps
1.0038	S 235 JRG2	Fe 360 B(FN)	RSt 37-2	E 24-2 NE	Fe 360 BFN	40 B	A 570 Gr 36		SM 400 A	St3ps; sp
1.0114	S 235 JO	Fe 360 C	St 37-3 U	E 24-3	Fe 360 C	40 C			SM 400 B	
1.0116	S 235 J2G3	Fe 360 D1	St 37-3 N	E 24-4	Fe 360 D	40 D	A 515 Gr 55 / A 573 Gr 70			St3kp
1.0117	S 235 J2G4	Fe 360 D2								
1.0044	S 275 JR	Fe 430 B	St 44-2	E 28-2	Fe 430 B	43 B	A 283 D / A 36	SS 400		St4ps; sp
1.0143	S 275 JO	Fe 430 C	St 44-3 U	E 28-3	Fe 430 C	43 C	A 578 Gr 70 / A 572 Gr 42			
1.0144	S 275 J2G3	Fe 430 D1	St 44-3 N	E 28-4	Fe 430 D	43 D	A 633 Gr A / A 283 D			St4kp
1.0145	S 275 J2G4	Fe 430 D2								
1.0045	S 355 JR	Fe 510 B		E 36-2	Fe 510 B	50 B	A 572 Gr 50 / A 678 Gr A	SS 50 / SS 490	SM 490 A	
1.0553	S 355 JO	Fe 510 C	St 52-3 U	E 36-3	Fe 510 C	50 C	A 441 / A 633 C		SM 490 B	
1.0570	S 355 J2G3	Fe 510 D1	St 52-3 N		Fe 510 D	50 D	A 633 D		SS 490 C	17 GS
1.0577	S 355 J2G4	Fe 510 D2							SS 490 YA	
1.0595	S 355 K2G3	Fe 510 DD1		E 36-4		50 DD			SS 490 YB	
1.0596	S 355 K2G4	Fe 510 DD2							SS 520 B	
1.0050	E 295	Fe 490-2	St 50-2	A 50-2	Fe 490 Fe 480		A 570 gr 50 / A 572 Gr 50	SS 500		St5ps; sp
1.0060	E 335	Fe 590-2	St 60-2	A 60-2	Fe 590 Fe 580				SM 490 A	St6ps; sp
1.0070	E 360	Fe 690-2	St 70-2	A 70-2	Fe 690 Fe 680				SS 490 B	

Sac ve Levha



Sac ve Levha

RULO SAC

Kalınlık: 1,20 mm – 25,00 mm

Genişlik: 1000 mm – 2600 mm



LEVHA SAC

Kalınlık: 5 mm – 200 mm

Genişlik: 1500 mm – 4000 mm

Uzunluk: 6000 mm – 12000mm

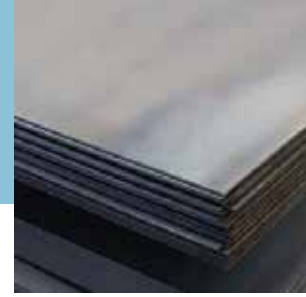

DKP SAC

Rulo Kalınlık: 0.40 mm – 3.00 mm

Rulo En: 1000, 1200, 1250, 1500 mm

Paket: 1000×2000 – 1250×2500

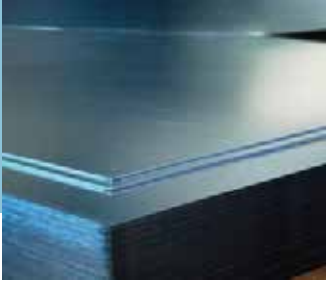

GALVANİZ SAC

Kalınlık: 0.40 – 4.00 mm

Genişlik: 550 – 1500 mm

Kaplama Kalınlığı: 122-350 gr/m2



KAZAN SAC

Genişlik : 1500 -3000 mm

Et Kalınlığı : 5 - 60 mm

Kalite : P265GH, P355GH

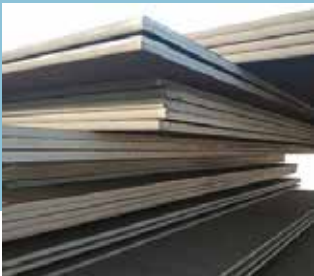

ESNEMEYE MUKAVEMETLİ SACLAR

HB 400 HB 450 HB 500 MC Kalite



AŞINMAYA MUKAVEMETLİ SAÇLAR

Ebat: 2 mm – 120 mm

HB 400,

HB 450,

HB 500,

HB 550,

HB 600

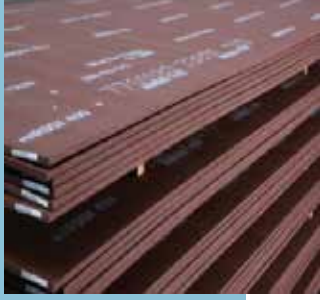

CORTEN ESKİTME ÇELİK

Kalınlık: 1,00 mm - 20,00 mm



ZIRH ÇELİĞİ

Protection 280 T

Kalınlık: 4.00-25.40 mm
Sertlik: 270-330 HBW

Protection 440 T
Kalınlık: 4.00-20.40 mm
Sertlik: 420-480 HBW

Protection 500 T
Kalınlık: 4.00-24.00 mm
Sertlik: 420-480 HBW

Protection 600 T
Kalınlık: 4.00-20.00 mm
Sertlik: 570-650 HBW



Kazan Çelikleri Kalite Karşılaştırma Tablosu

	AVRUPA	ALMANYA	FRANSA	İTALYA	İNGİLTERE	İSPANYA	ABD	JAPONYA
Materyal#	EN 10028-2	DIN 17155	NFA 36-205	UNI 5869	BS 1501	UNE 36087	ASTM	JIS G3115
1.0345	P 235 GH	HI	A 37 CP	Fe 360 - 1KW	161 Gr 360 / 164 Gr 360	A 37 RCI	A 515 Gr 55 / A 414 Gr C / A 516 Gr 55	SPV 24
1.0425	P 265 GH	HI	A 42 CP	Fe 410 - 1KW	161 Gr 400 / 164 Gr 400	A 42 RCI	A 285 Gr C / A 414 Gr D / A 662 Gr A	
1.0481	P 295 GH	17 Mn 4	A 48 CP	Fe 510 - 1KW	224 Gr 490	A 47 RCI	A 414 Gr E,F / A 516 Gr 65	SPV 32
1.0473	P 355 GH	19 Mn 6	A 52 CP	Fe E 355-2		A 52 RCI	A 414 Gr G / A 516 Gr 70 / A 537	SVG 410 / SGV 450
1.5415	16 Mo 3	15 Mo 3	15 D3	16 Mo 3	1503 / 243 B	16 Mo 3	A 204 Gr A	
1.7335	13 CrMo4-5	13 CrMo 4.4	15 CD 4-05	14 CrMo 3	620 Gr 27	14 CrMo 4.5	A 387 Gr 12 / A 182 (F11, 12)	
1.7380	10 CrMo9-10	10 CrMo 9 10	10 CD 9.10	12 CrMo 9.10	622 Gr 31		A 387 Gr 22 / A 182 (F22)	
1.7383	11 CrMo9-10			12 CrMo 9.10		12 CrMo 9.10		

Esnece Çelik Kaliteleri Karşılaştırma Tablosu

Kalınlık (mm)	C (%)	Mn (%)	P (%)	S (%)	Si (%)	Al (%)	Nb (%)	V (%)	Ti (%)	B (%)	Mo (%)	C _{eq} (CEV)	
S240MC	≤ 0.100	≤ 0.80	≤ 0.020	≤ 0.020	≤ 0.03	≥ 0.015	≤ 0.025	≤ 0.200	≤ 0.150			≤ 0.18	
S280MC	≤ 0.080			≤ 0.015								≤ 0.23	
S315MC	≤ 0.100	≤ 0.70		≤ 0.25									
S355MC		≤ 1.40		≤ 0.32									
S390MC	≤ 0.110	≤ 150		≤ 0.012								≤ 0.065	≤ 0.36
S420MC				≤ 0.120								≤ 0.080	≤ 0.38
S460MC	≤ 0.120	≤ 170		≤ 0.015								≤ 0.090	≤ 0.40
S500MC	≤ 0.100			≤ 0.220								≤ 0.42	
S550MC	≤ 0.120	≤ 190		≤ 0.015								≤ 0.150	≤ 0.44
S600MC	≤ 0.100	≤ 2.00		≤ 0.025								≤ 0.005	≤ 0.5
S650MC	≤ 0.100	≤ 2.10	≤ 0.005	≤ 0.25									
S700MC													

Mekanik Tablosu

Kalınlık (mm)	Direction	R _e (MPa)		R _m (MPa)	A ₈₀ (%)		A 5.65√S ₀ (%)	Bendingratio (th)*			KV-20°C (J)	KV-40°C (J)
		≤ 8	> 8		< 2	2-3		< 6	6-13	≥ 13		
S240MC	L	240 - 320		340 - 450	≥ 27		≥ 32				≥ 40	
	T	260 - 340		340 - 450	≥ 26		≥ 31		0		≥ 40	
S280MC	L	280 - 350		370 - 450	≥ 26		≥ 30				≥ 40	
	T	300 - 380		370 - 450	≥ 25		≥ 29		0		≥ 40	
S315MC	L	315 - 395		415 - 495	≥ 24		≥ 28				≥ 40	
	T	340 - 420		420 - 500	≥ 23		≥ 27		0		≥ 40	
S355MC	L	355 - 435		430 - 520	≥ 22		≥ 25				≥ 40	
	T	380 - 460		440 - 530	≥ 21		≥ 24		0		≥ 40	
S390MC	L	390 - 480		460 - 560	≥ 20		≥ 24				≥ 40	
	T	420 - 500		470 - 570	≥ 19		≥ 23		0		≥ 40	
S420MC	L	420 - 520		490 - 600	≥ 18		≥ 22				≥ 40	
	T	450 - 550		500 - 600	≥ 17		≥ 21	≥ 0.2		≥ 0.5	≥ 40	
S460MC	L	460 - 560		520 - 640	≥ 15		≥ 18				≥ 40	
	T	490 - 590		530 - 640	≥ 14		≥ 17	≥ 0.6		≥ 1	≥ 40	
S500MC	L	500 - 600		560 - 700	≥ 15	≥ 16	≥ 19				≥ 40	
	T	530 - 630		570 - 700	≥ 14	≥ 15	≥ 18	≥ 0.6		≥ 1	≥ 40	
S550MC	L	550 - 650		620 - 750	≥ 12		≥ 14				≥ 40	
	T	580 - 680		630 - 750	≥ 11		≥ 13	≥ 0.8		≥ 15	≥ 40	
S600MC	L	≥ 600		650 - 820	≥ 11		≥ 13				≥ 40	
	T	≥ 620		660 - 820	≥ 10		≥ 12		≥ 15		≥ 40	
S650MC	L	≥ 650	≥ 630	700 - 850	≥ 10		≥ 14				≥ 40	≥ 27
	T	≥ 670	≥ 650	710 - 880	≥ 10		≥ 12		≥ 18		≥ 40	≥ 27
S700MC	L	≥ 700	≥ 680	750 - 930	≥ 10		≥ 14				≥ 40	≥ 27
	T	≥ 720	≥ 700	760 - 950	≥ 10		≥ 12		≥ 18		≥ 40	≥ 27

İkinci Kalite Over Rolling Hadde



NEDEN İKİNCİ KALİTE ?

Bu ürünler fabrika haddeleme esnasında oluşan tufal batması, karbon yanığı, ölçü bozuğu, radius patlağı ve boy kıtası gibi nedenlerden ötürü bu sınıflandırmaya tabi tutulmaktadır. Malzeme 1. kalitelerde olduğu gibi aynı kimyasal kompozisyona ve mekanik değerlere sahiptir.

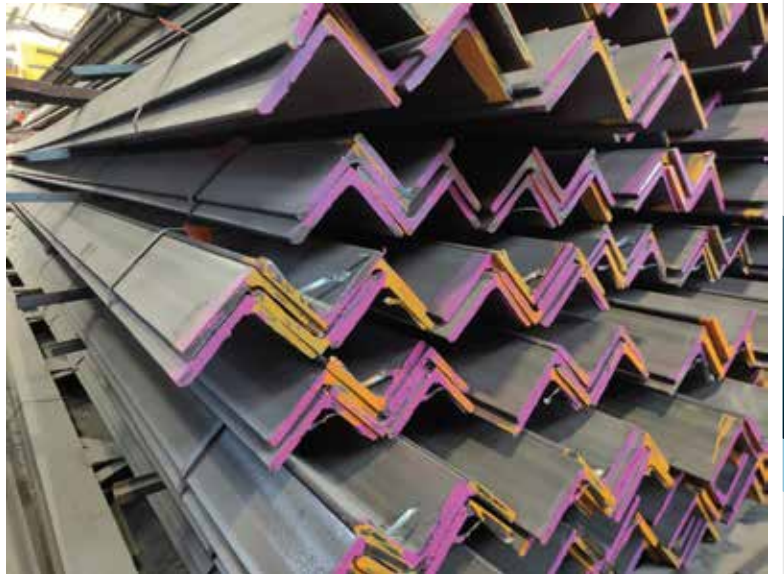

Vinç Rayları

A 45 Vinç Rayı

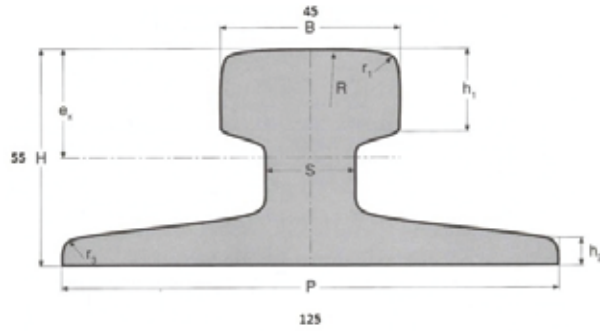

Designation	Weight		B	S	P	H	R	h ₁	H ₂	r ₁	r ₂	e _x
	Kg/m	Lbs/yd										
A 45	22,1	44,55	45	24	125	55	400	20,0	8	4	4	33,3

A 55 Vinç Rayı

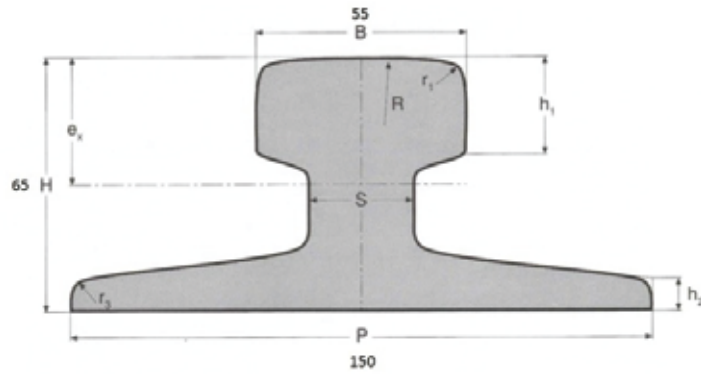

Designation	Weight		B	S	P	H	R	h ₁	H ₂	r ₁	r ₂	e _x
	Kg/m	Lbs/yd										
A 55	31,8	64,11	55	31	150	65	400	25,0	9	5	5	39,0

A 65 Vinç Rayı

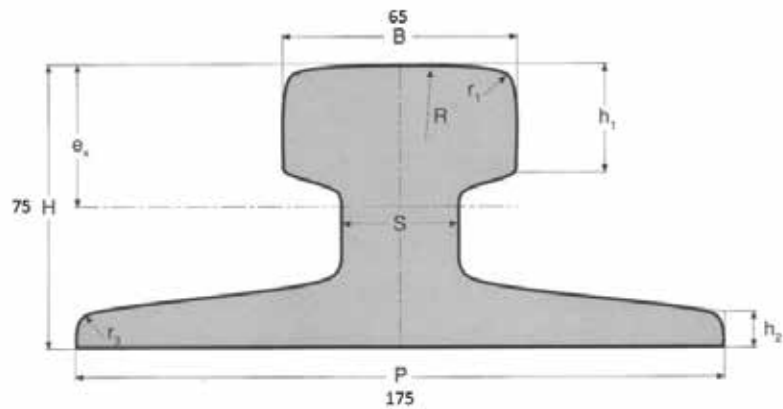

Designation	Weight		B	S	P	H	R	h ₁	H ₂	r ₁	r ₂	e _x
	Kg/m	Lbs/yd										
A 65	43,1	86,89	65	38	175	75	400	30,0	10	6	5	44,7

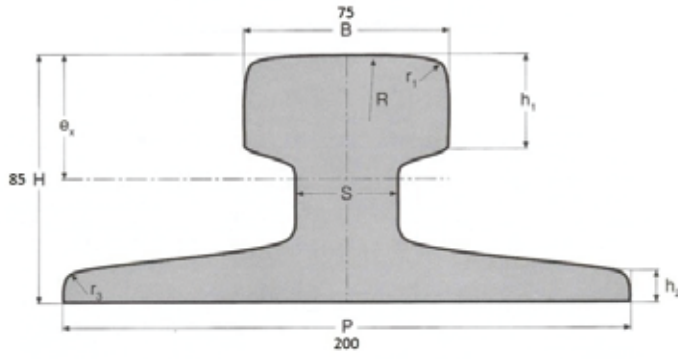

A 75 Vinç Rayı

Designation	Weight		B	S	P	H	R	h ₁	H ₂	r ₁	r ₂	e _x
	Kg/m	Lbs/yd										
A 75	56,2	113,29	75	45	200	85	500	35,0	11	8	6	50,4

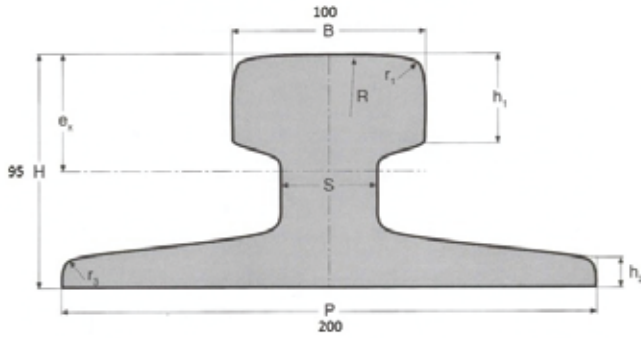

A 100 Vinç Rayı

Designation	Weight		B	S	P	H	R	h ₁	H ₂	r ₁	r ₂	e _x
	Kg/m	Lbs/yd										
A 100	74,3	149,78	100	60	200	95	500	40,0	12	10	6	52,9

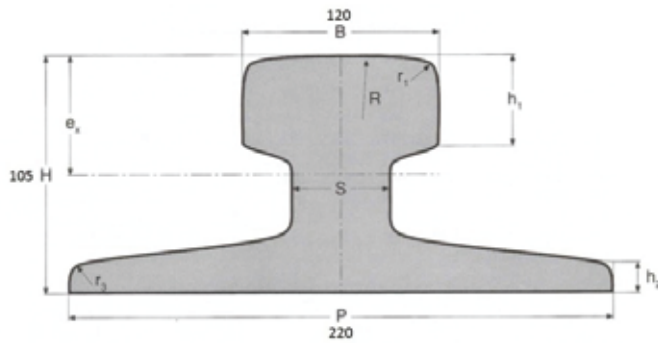

A 120 Vinç Rayı

Designation	Weight		B	S	P	H	R	h ₁	H ₂	r ₁	r ₂	e _x
	Kg/m	Lbs/yd										
A 120	100,0	201,59	120	72	220	105	600	47,5	14	10	6	57,9

A 150 Vinç Rayı

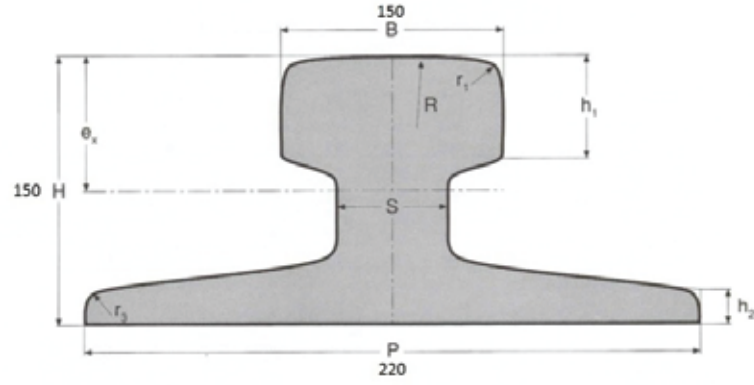

Designation	Weight		B	S	P	H	R	h ₁	h ₂	r ₁	r ₂	e _x
	Kg/m	Lbs/yd										
A 150	150.3	302.99	150	80	220	150	800	50.0	14	10	6	77.3

S 10 Vinç Rayı

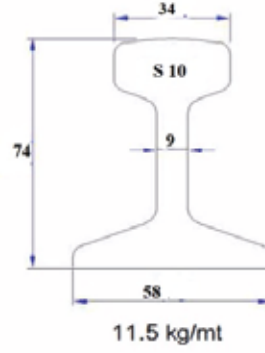

Rail Type	H mm	B1 mm	B2 mm	S mm
S 10	74	34	58	9

S 12 Vinç Rayı

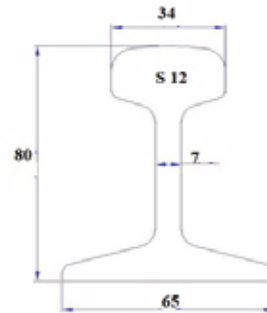

Rail Type	H mm	B1 mm	B2 mm	S mm
S 12	80	34	65	7

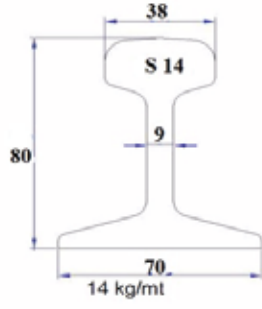

S 14 Vinç Rayı

Rail Type	H mm	B1 mm	B2 mm	S mm
S 14	80	38	70	9

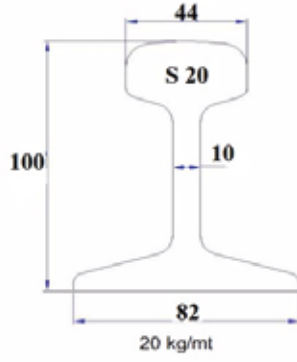

S 20 Vinç Rayı

Rail Type	H mm	B1 mm	B2 mm	S mm
S 20	100	44	82	10





T.C.
TÜRK PATENT ve MARKA KURUMU

MARKA TESCİL BELGESİ

Marka No : 2021 131821 - Ticaret - Hizmet

INOVA
STEEL

Marka Sahibi : İNOVA STEEL DİŞ TİCARET LİMİTED ŞİRKETİ
TÜRKİYE CUMHURİYETİ
KÜÇÜK ÇİĞLİ MAH. 57181 SK. 72 ÇİĞLİ İZMİR
Emlak : 06
İlişktedir.



İşbu Marka 21/09/2021 tarihinden itibaren ON YIL süreyle
23/03/2022 tarihinde tescil edilmiştir.

H. A.
Prof. Dr. Halil ASAN
Türk Patent ve Marka
Kurumu Başkanı

**TURK
PATENT**



T.C.
TÜRK PATENT ve MARKA KURUMU

MARKA TESCİL BELGESİ

Marka No : 2021 131821 - Ticaret - Hizmet

INOVA
STEEL

Marka Sahibi : İNOVA STEEL DİŞ TİCARET LİMİTED ŞİRKETİ
TÜRKİYE CUMHURİYETİ
KÜÇÜK ÇİĞLİ MAH. 57181 SK. 72 ÇİĞLİ İZMİR
Emlak : 06
İlişktedir.



İşbu Marka 21/09/2021 tarihinden itibaren ON YIL süreyle
23/03/2022 tarihinde tescil edilmiştir.

H. A.
Prof. Dr. Halil ASAN
Türk Patent ve Marka
Kurumu Başkanı

**TURK
PATENT**

CERTIFICATE



Bu Sertifika / This certificate is granted to the organization



INOVA STEEL DIŞ TİCARET LİMİTED ŞİRKETİ

Küçük Çiftlik Mah. 875A/1. Sokak No: 7 İç Kapı No: 2 ÇGB / İzmit / Türkiye

KIOSCERT Belgelendirme tarafından denetlenmiş ve uygulanmakta olduğu Çevre Yönetim Sistemini

It is audited by KIOSCERT Certification and applied Environmental Management System meet the requirements of

ISO 14001:2015

standartına aşağıdaki kapsamda veyahutta olduğu görülmüştür.
Standard for the following activities.

Belgelendirme Kapsamı / Certification Scope

DEMİR-ÇELİK YARI MAMÜL VE MAMÜLLERİN TEMİN EDİLMESİ, ALIMI, SATIMI, BU FAALİYETLERE İLİŞKİN GÜMRÜK, DIŞ TİCARET, ÜRETİM, LOJİSTİK, YÖNETİM VE İDARI ORGANİZASYON FAALİYETLERİ

SUPPLY, PURCHASE, SALE OF IRON-STEEL SEMI-PRODUCTS AND PRODUCTS, INCLUDING THESE ACTIVITIES RELATED CUSTOMS, FOREIGN TRADE, PRODUCTION, LOGISTICS, MANAGEMENT AND ADMINISTRATIVE ORGANIZATION ACTIVITIES

Sertifika İlk Yayın Tarihi / 04.02.2022

Certificate First Issue Date

Sertifika Yayın Tarihi / 04.02.2022

Certificate Release Date

Sertifika Revizyon No ve Tarihi / 00 / -

Certificate Revision Number and Date

Sertifika Geçerlilik Tarihi / 03.02.2023

Certificate Validity Date

Sertifika No / EMS-22-0402-INO

Certificate No

Belge Periyodu / 3 Yıl (Years)

Certificate Period



[Handwritten Signature]



CERTIFICATE



Bu Sertifika / This certificate is granted to the organization



INOVA STEEL DIŞ TİCARET LİMİTED ŞİRKETİ

Küçük Çiftlik Mah. 875A/1. Sokak No: 7 İç Kapı No: 2 ÇGB / İzmit / Türkiye

KIOSCERT Belgelendirme tarafından denetlenmiş ve uygulanmakta olduğu Müşteri Memnuniyeti Yönetim Sistemini

It is audited by KIOSCERT Certification and applied Customer Satisfaction Management System meet the requirements of

ISO 10002:2018

standartına aşağıdaki kapsamda veyahutta olduğu görülmüştür.
Standard for the following activities.

Belgelendirme Kapsamı / Certification Scope

DEMİR-ÇELİK YARI MAMÜL VE MAMÜLLERİN TEMİN EDİLMESİ, ALIMI, SATIMI, BU FAALİYETLERE İLİŞKİN GÜMRÜK, DIŞ TİCARET, ÜRETİM, LOJİSTİK, YÖNETİM VE İDARI ORGANİZASYON FAALİYETLERİ

SUPPLY, PURCHASE, SALE OF IRON-STEEL SEMI-PRODUCTS AND PRODUCTS, INCLUDING THESE ACTIVITIES RELATED CUSTOMS, FOREIGN TRADE, PRODUCTION, LOGISTICS, MANAGEMENT AND ADMINISTRATIVE ORGANIZATION ACTIVITIES

Sertifika İlk Yayın Tarihi / 04.02.2022

Certificate First Issue Date

Sertifika Yayın Tarihi / 04.02.2022

Certificate Release Date

Sertifika Revizyon No ve Tarihi / 00 / -

Certificate Revision Number and Date

Sertifika Geçerlilik Tarihi / 03.02.2023

Certificate Validity Date

Sertifika No / CSMS-22-0402-INO

Certificate No

Belge Periyodu / 3 Yıl (Years)

Certificate Period



[Handwritten Signature]



CERTIFICATE



Bu Sertifika / This certificate is granted to the organization



INOVA STEEL DİŐ TİCARET LİMİTED ŐIRKETİ

Kıyık CĐĐ Meh. 8718/1. Sokak No: 7 İ Kapa No: 2 CĐĐ / İsmir / Tőrkiye

KIOSCERT Belgelendirme tarafından denetlenmiŐ ve uygulanmakta olduĐu Kalite Yönetim Sistemimiz
is audited by KIOSCERT Certification and applied
Quality Management System meet the requirements of

ISO 9001:2015

standartına aŐaĐıdaki kapsamda uymakta olduĐu gőrülenmiŐtir.
Standard for the following activities.

Belgelendirme Kapsamı / Certification Scope

DEMİR-ÇELİK YARI MAMŐL VE MAMŐLLERİN TEMİN EDİLMESİ, ALIMI, SATIMI, BU FAALİYETLERE İLİŐİN GŐMRŐK, DİŐ TİCARET, ÜRETİM, LOĐİSTİK, YÖNETİM VE İDARI ORGANİZASYON FAALİYETLERİ

SUPPLY, PURCHASE, SALE OF IRON-STEEL SEMI-PRODUCTS AND PRODUCTS, INCLUDING THESE ACTIVITIES RELATED CUSTOMS, FOREIGN TRADE, PRODUCTION, LOGISTICS, MANAGEMENT AND ADMINISTRATIVE ORGANIZATION ACTIVITIES

Sertifika İb Yayın Tarihi / 04.02.2022

Certificate First Issue Date

Sertifika Yayın Tarihi / 04.02.2022

Certificate Release Date

Sertifika Revizyon No ve Tarih / 00 / -

Certificate Revision Number and Date

Sertifika Geçerlilik Tarihi / 03.02.2023

Certificate Validity Date

Sertifika No / 046-22-0402-İNO

Certificate No

Belge Periyodu / 3 Yıl (Years)

Certificate Period



CERTIFICATE



Bu Sertifika / This certificate is granted to the organization



INOVA STEEL DİŐ TİCARET LİMİTED ŐIRKETİ

Kıyık CĐĐ Meh. 872A/1. Sokak No: 7 İ Kapa No: 2 CĐĐ / İsmir / Tőrkiye

KIOSCERT Belgelendirme tarafından denetlenmiŐ ve uygulanmakta olduĐu İş Sağlığı ve GüvenliĐi Yönetim Sistemimiz
is audited by KIOSCERT Certification and applied
Occupational and Safety Management System meet the requirements of

ISO 45001:2018

standartına aŐaĐıdaki kapsamda uymakta olduĐu gőrülenmiŐtir.
Standard for the following activities.

Belgelendirme Kapsamı / Certification Scope

DEMİR-ÇELİK YARI MAMŐL VE MAMŐLLERİN TEMİN EDİLMESİ, ALIMI, SATIMI, BU FAALİYETLERE İLİŐİN GŐMRŐK, DİŐ TİCARET, ÜRETİM, LOĐİSTİK, YÖNETİM VE İDARI ORGANİZASYON FAALİYETLERİ

SUPPLY, PURCHASE, SALE OF IRON-STEEL SEMI-PRODUCTS AND PRODUCTS, INCLUDING THESE ACTIVITIES RELATED CUSTOMS, FOREIGN TRADE, PRODUCTION, LOGISTICS, MANAGEMENT AND ADMINISTRATIVE ORGANIZATION ACTIVITIES

Sertifika İb Yayın Tarihi / 04.02.2022

Certificate First Issue Date

Sertifika Yayın Tarihi / 04.02.2022

Certificate Release Date

Sertifika Revizyon No ve Tarih / 00 / -

Certificate Revision Number and Date

Sertifika Geçerlilik Tarihi / 03.02.2023

Certificate Validity Date

Sertifika No / İSMS-22-0402-İNO

Certificate No

Belge Periyodu / 3 Yıl (Years)

Certificate Period



İNOVA

STEEL DIŐ TİCARET LTD. ŐTİ.

Türkiye'nin
Global Demir ve Çelik Tedarikçisi

Genel Merkez

Yalı Mh. 6471 Sk. Med Office No. 27

K. 7 Apt. 12 Karşıyaka

Türkiye

0 (232) 203 41 23

satis@inovademir.com

www.inovasteel.com.tr